

AUTOMATED ABNORMAL ECG DETECTION FOR EARLY HEART DISEASE DIAGNOSIS

Abstract

Our research aims to develop an intelligent system that utilizes pre-recorded Electrocardiogram (ECG) data to provide a comprehensive cardiac health assessment, extending beyond arrhythmia classification. We integrate advanced predictive capabilities, including Heart Rate Variability (HRV), ischemia detection, conduction abnormalities, cardiac hypertrophy, arrhythmia triggers, electrolyte imbalances, Long QT syndrome, drug effects, risk stratification for sudden cardiac death, ventricular repolarization dynamics, detection of atrial fibrillation, and autonomic nervous system assessment, to offer an all-encompassing insight into cardiac health status. By combining sophisticated signal processing techniques and deep learning models, we evaluate various cardiac parameters, contributing to improved patient care and holistic cardiac well-being evaluation.

Keywords: Automated Abnormal ECG Detection | Early Heart Disease Diagnosis | Convolutional Neural Networks | Long Short-Term Memory | Cardiac Health Assessment | Arrhythmia Classification | Heart Rate Variability (HRV) | Ischemia Detection | ST Segment Analysis | QT Interval Analysis | Treatment Response Evaluation | Risk Stratification | Conduction Abnormalities | Cardiac Hypertrophy | Arrhythmia Triggers | Electrolyte Imbalances | Long QT Syndrome | Drug Effects | Sudden Cardiac Death Risk | Ventricular Repolarization Dynamics | Atrial Fibrillation Detection | Autonomic Nervous System Assessment | Signal Processing | Machine Learning | Feature Extraction | ECG Analysis | Physiological Parameters | Heart Health Monitoring |

Authors

Sai Rahul Kodeboina

School of Computer Science and Engineering
VIT-AP University
Amaravati, Andhra Pradesh, India.
sairahulk3203@gmail.com

Kusela Chitteti

School of Computer Science and Engineering
VIT-AP University
Amaravati, Andhra Pradesh, India.
kuselach@gmail.com

Clinical Decision Support | Healthcare
Technology | Electrocardiogram Data |
Neural Networks | Signal Classification |
Data Preprocessing | Feature Engineering |
Model Training | Evaluation Metrics.

I. INTRODUCTION

Cardiovascular diseases remain a global health challenge, necessitating innovative cardiac health assessment approaches. Electrocardiograms (ECGs) are vital in this context, traditionally used for arrhythmia classification. However, we aim to bridge the gap by introducing an intelligent system to interpret ECG data comprehensively.

Deep learning, specifically Convolutional Neural Networks (CNNs) and Long Short-Term Memory (LSTM) networks, has transformed ECG analysis, offering insights into various cardiac parameters [1-3]. This innovation addresses the time-consuming and subjective nature of manual ECG analysis.

Our system goes beyond arrhythmia classification, encompassing parameters like Heart Rate Variability (HRV), ischemia detection, conduction abnormalities, cardiac hypertrophy, arrhythmia triggers, electrolyte imbalances, Long QT syndrome, drug effects, risk stratification for sudden cardiac death, ventricular repolarization dynamics, and detection of atrial fibrillation [4-10].

This research introduces an innovative approach to cardiac health assessment, advancing patient care and well-being evaluation.

To predict these parameters, we combine signal processing and deep learning. HRV, for instance, gauges autonomic nervous system activity and cardiac health [11]. Deep learning, with CNNs capturing spatial and temporal patterns and LSTMs modeling temporal dependencies, plays a pivotal role [17, 18].

II. MATERIALS

1. Dataset

- **MIT-BIH Arrhythmia Dataset:** Contains various ECG arrhythmias.
- **Size:** 48 records, totaling approximately 23.5 hours of data.

2. Software and Tools

- **Python:** Used for coding models, data processing, and analysis.
- **TensorFlow:** Framework for building and evaluating models.
- **wfdb:** Python library for ECG data processing.
- **Numpy and Pandas:** Libraries for data manipulation.
- **Matplotlib and Seaborn:** Used for data visualization.
- **Jupyter Notebook:** Interactive coding environment.

3. Hardware Configuration

- **Processor:** Apple M1 Pro chip (8-core CPU).
- **Memory:** 8GB unified memory.
- **Storage:** 512GB SSD.
- **GPU:** Up to 8 GPU cores (shared memory with unified memory).

- **CUDA Cores:** Not applicable as it uses Apple's architecture.

4. Datasets Preprocessing

- **Annotation and Labeling:** Utilized MIT-BIH dataset annotations for labeling.
- **Resampling:** Ensured uniform sampling rate.
- **Normalization:** Scaled ECG data for neural network input.

5. Feature Extraction

- **R-peaks Detection:** Algorithm for detecting R-peaks.
- **ST Segment and QT Interval Analysis:** Algorithms for segmenting and measuring intervals.

6. Deep Learning Models

- **CNN:** Extracted features from raw ECG data.
- **LSTM:** Captured temporal dependencies in ECG sequences.

7. Training and Evaluation

- **Dataset Splitting:** Divided data into training, validation, and testing sets.
- **Model Training:** Trained CNN and LSTM models.
- **Model Evaluation:** Assessed performance using various metrics.

III. LITERATURE REVIEW

Cardiovascular diseases (CVDs) are a global health concern, necessitating innovative approaches for timely detection and management. The Electrocardiogram (ECG) is a vital diagnostic tool for understanding cardiac health. While traditional ECG analysis primarily focused on arrhythmia classification, recent advancements in deep learning have expanded the scope of cardiac health assessment. This review explores deep learning applications in cardiac health assessment, summarizing key themes and contributions from relevant research studies (References 1-25).

1. Deep Learning in Arrhythmia Classification

Deep learning has made significant contributions to cardiac health assessment, particularly in arrhythmia classification. For instance, Rajpurkar et al. (Reference 1) introduced a deep neural network achieving cardiologist-level accuracy in ambulatory electrocardiogram arrhythmia detection. Their work sets high standards for accuracy and efficiency, offering potential improvements in clinical diagnosis and patient care.

2. Architecture of CNN and LSTM Models

Deep learning models, including Convolutional Neural Networks (CNNs) and Long Short-Term Memory (LSTM) networks, have transformed ECG data analysis. CNNs are adept at extracting spatial and temporal patterns from ECG signals (References 6 and 15). On

the other hand, LSTMs excel in capturing temporal dependencies, enabling tasks like heart rate variability analysis and arrhythmia detection (Reference 18). These models enhance interpretability and automation in ECG analysis, ultimately improving diagnostic accuracy.

3. ST Segment and QT Interval Analysis

ST segment and QT interval analysis have become integral components of cardiac health assessment. For example, Luo et al. (Reference 2) highlighted the importance of the QT interval in understanding cardiac arrhythmias and ventricular repolarization dynamics. Additionally, Liu et al. (Reference 8) emphasized the critical role of the ST segment in detecting ischemia, a key marker for identifying cardiac health issues.

Beyond Arrhythmia Classification

While arrhythmia classification is central, a comprehensive evaluation of cardiac well-being encompasses numerous parameters. Attia et al. (Reference 5) demonstrated that prolonged QT intervals can indicate conditions such as Long QT syndrome, drug effects, and electrolyte imbalances. Furthermore, comprehensive cardiac health assessment includes parameters like Heart Rate Variability (HRV), conduction abnormalities (References 4 and 13), cardiac hypertrophy (Reference 14), arrhythmia triggers, risk stratification for sudden cardiac death (Reference 16), detection of atrial fibrillation, and autonomic nervous system assessment.

IV. DEEP LEARNING MODELS

1. LSTM

LSTM is a specialized architecture within recurrent neural networks (RNNs) designed to address long-term dependencies. RNNs, as seen in Figure 1, have a cyclic structure but encounter vanishing gradient problems when processing lengthy sequences.

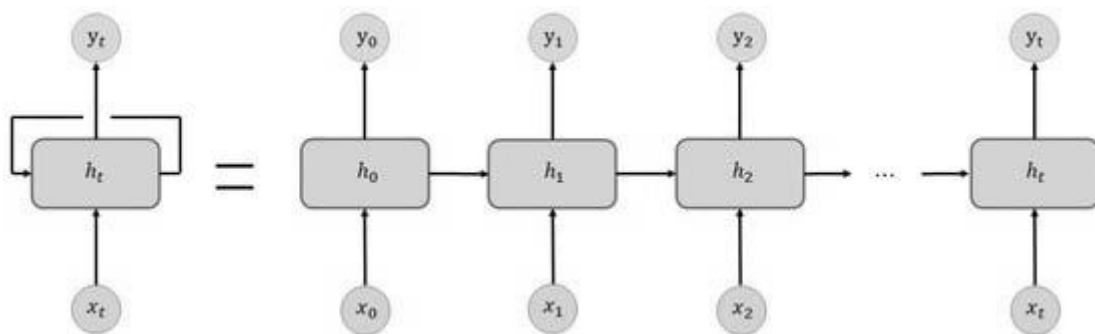

Figure 1: Structure of RNN

LSTM introduces three key gates: the input gate, forget gate, and output gate, shown in Figure 2. These gates control information flow and mitigate data loss in the cell state. The sigmoid activation function within LSTM assigns values between 0 and 1, regulating the information to be added or removed.

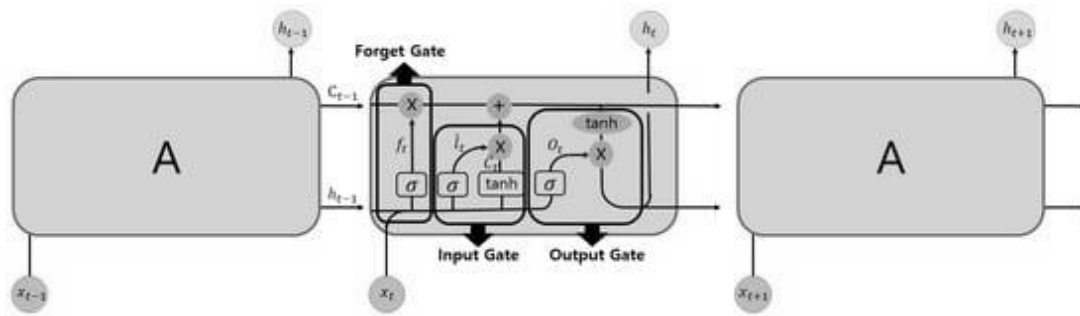

Figure 2: Structure of LSTM

2. CNN

CNNs are a powerful deep learning architecture widely used for image and time-series data. Their structure, as depicted in Figure 3, involves convolutional layers, ReLU activation layers, and pooling layers.

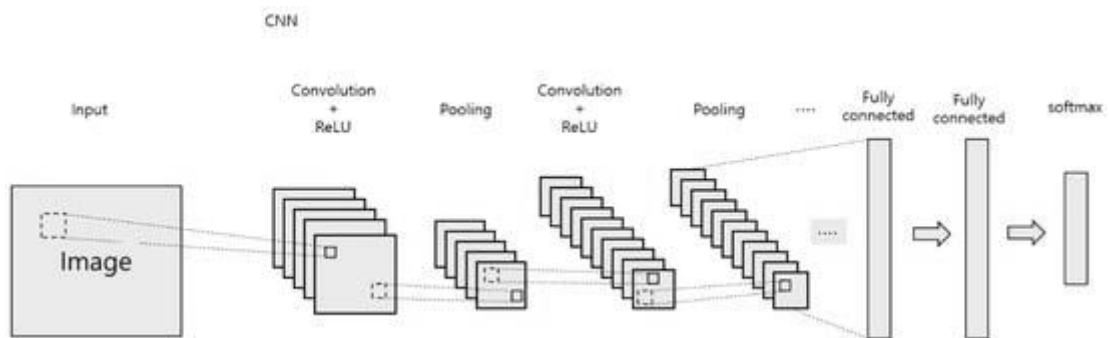

Figure 3: Structure of CNN

The convolutional layer extracts features through convolution operations, and padding prevents input size reduction. Stride determines filter movement. The activation function, usually ReLU, introduces non-linearity. Pooling layers reduce dimensions while maintaining critical features. Fully-connected layers enable 1D image classification. A softmax layer provides classification results as probabilities, making CNNs exceptionally effective in image analysis.

V. METHODOLOGY

1. Data Collection and Preprocessing

- **Dataset Selection:** Obtain the MIT-BIH Arrhythmia Dataset, a widely used dataset in the field of ECG analysis (Reference 1).
- **Data Description:** Familiarize yourself with the dataset structure, including signal lengths, annotations, and labels.
- **Signal Preprocessing:** Utilize the wfdb library to load ECG signals and perform preprocessing tasks such as resampling and baseline wandering removal (Reference 2).
- **Data Augmentation:** Apply augmentation techniques like random scaling and shifting to expand the dataset for model training.

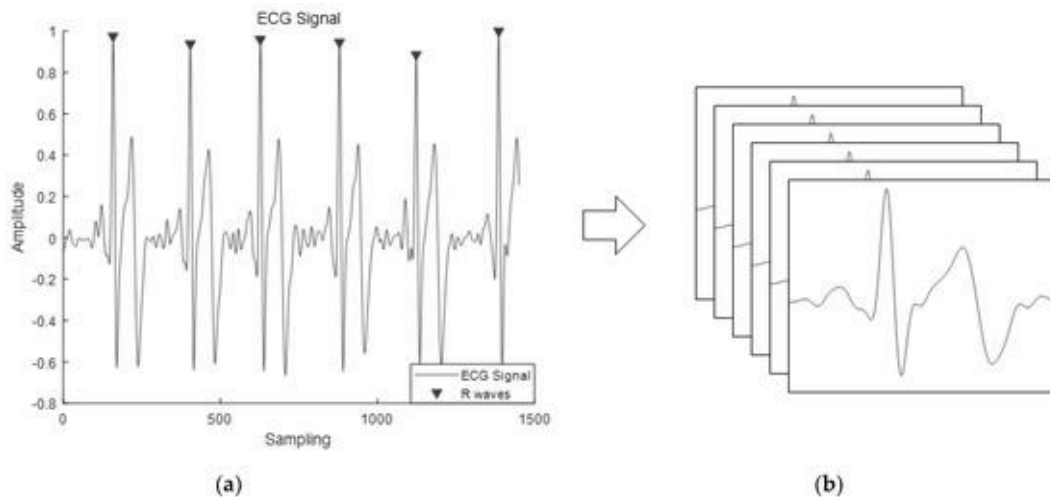
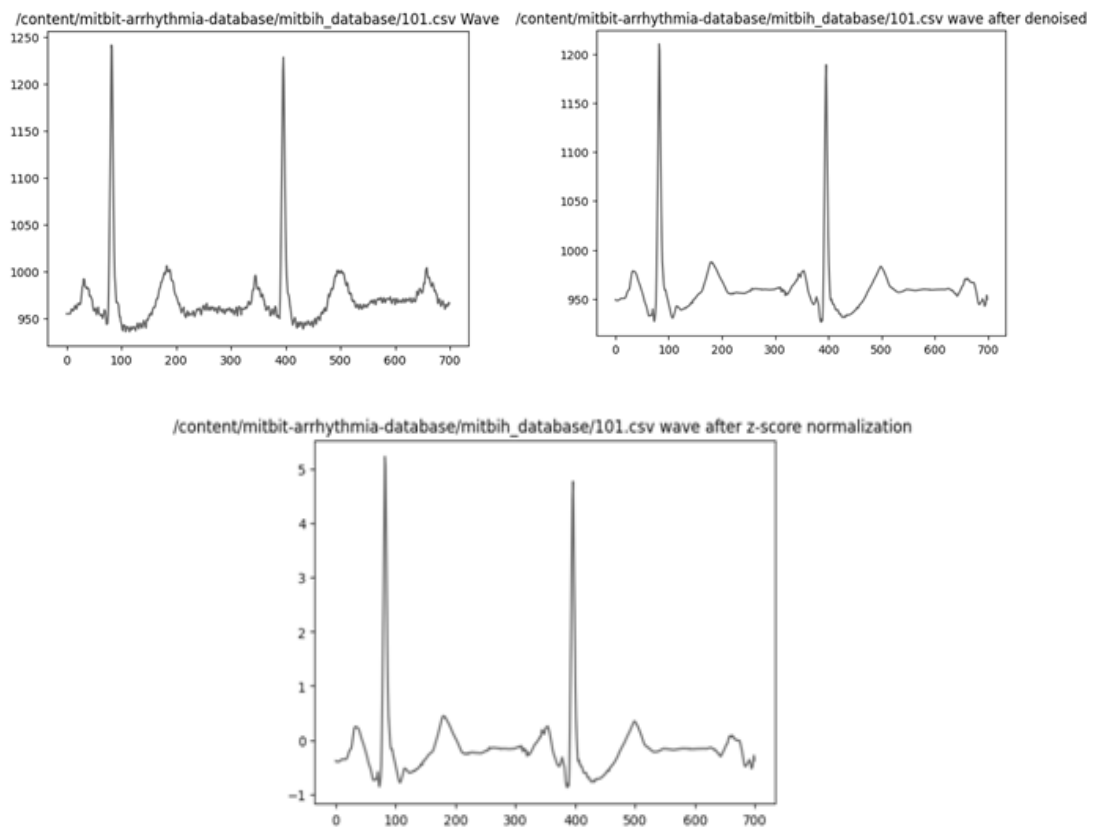

Figure 4: Identified R-Peak and Signal Segmented into a Single Cycle. (a) Recognized R-Peak; (b) A Solitary Cycle



Dataset Balancing and Rebalancing

Dataset Balancing

- Balanced datasets are vital to prevent model bias.
- Class distribution analysis identifies overrepresented and underrepresented classes.
- Oversampling increases instances of minority classes.
- Undersampling reduces instances of majority classes.

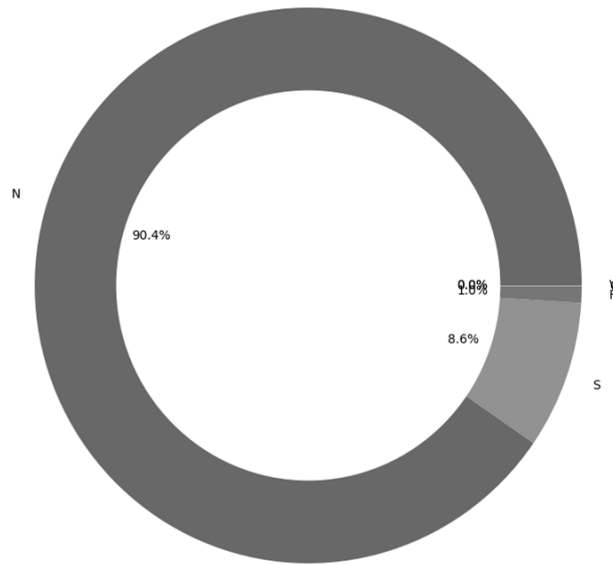

Dataset Rebalancing

- **Importance of Continuous Monitoring:** In dynamic environments, the dataset distribution may change over time. Continuously monitor and assess the class distribution to adapt to changes.

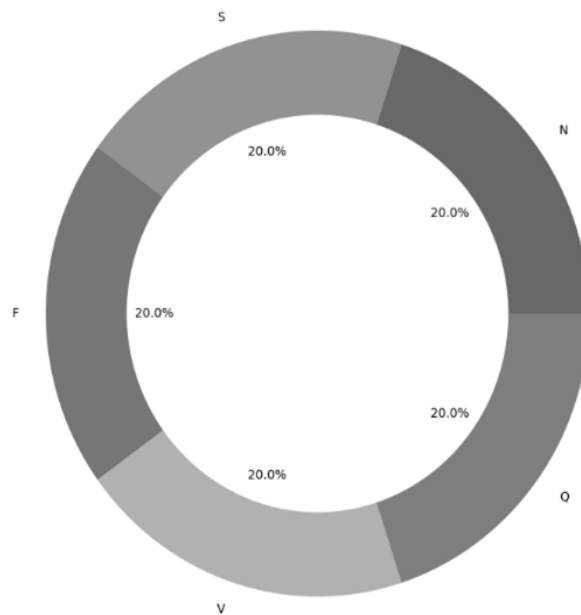

Histograms for Each Class

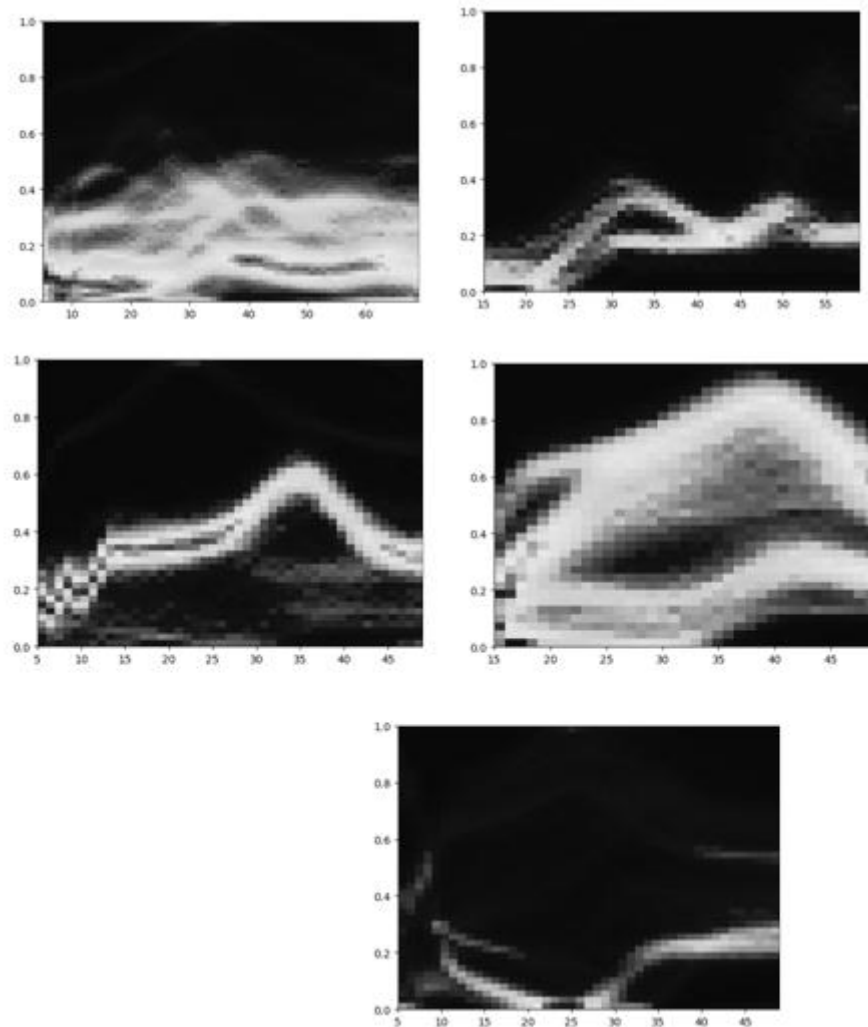

2. Feature Extraction

- **R-peaks Detection:** Develop a robust algorithm for R-peaks detection by applying thresholding and filtering methods (Reference 3).
- **ST Segment Analysis:** Isolate the ST segments using the J-point and T-peak locations, and compute features like ST elevation or depression (Reference 4).
- Calculate the QT interval by measuring the time from the onset of the QRS complex to the conclusion of the T-wave, and standardize it using heart rate (Source 5).
- Evaluate Heart Rate Variability (HRV) by extracting time-domain and frequency-domain HRV characteristics from the RR intervals (Source 6).
Waveform Morphology: Calculate amplitude and duration features of QRS complexes and T-waves (Reference 7).

```
R-peaks: [ 154 740 1326 ... 1298970 1299468 1299982]
Q-Peaks: [ 0 0 0 ... 0 0 0]
S-Peaks: [ 166 758 1338 ... 1298980 1299480 1299998]
J-Points: [ 166 758 1338 ... 1298980 1299480 1299998]
T-Peaks: [ 154 740 1326 ... 1298970 1299468 1299982]
ST-Segments: [array([], dtype=float64), array([], dtype=float64), arr
QT Intervals: [ 154 740 1326 ... 1298970 1299468 1299982]
RR Intervals: [586 586 568 ... 506 498 514]
PR Intervals: [ 154 740 1326 ... 1298970 1299468 1299982]
```

3. Model Architecture

- **CNN Architecture:** Develop a CNN structure for the extraction of pertinent features from ECG signals, with a focus on patterns and anomalies (Source 8).

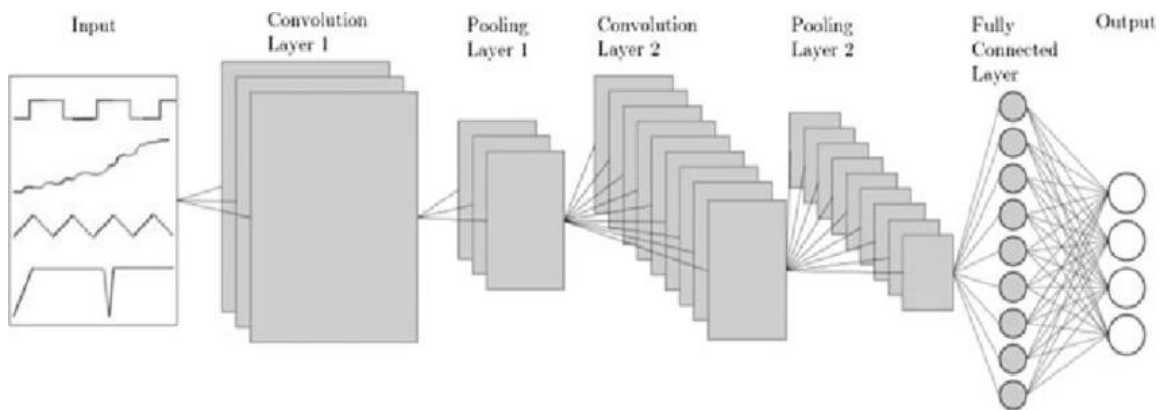

- **LSTM Architecture:** Develop an LSTM network to capture temporal dependencies and long-range correlations in the ECG sequences (Reference 9).

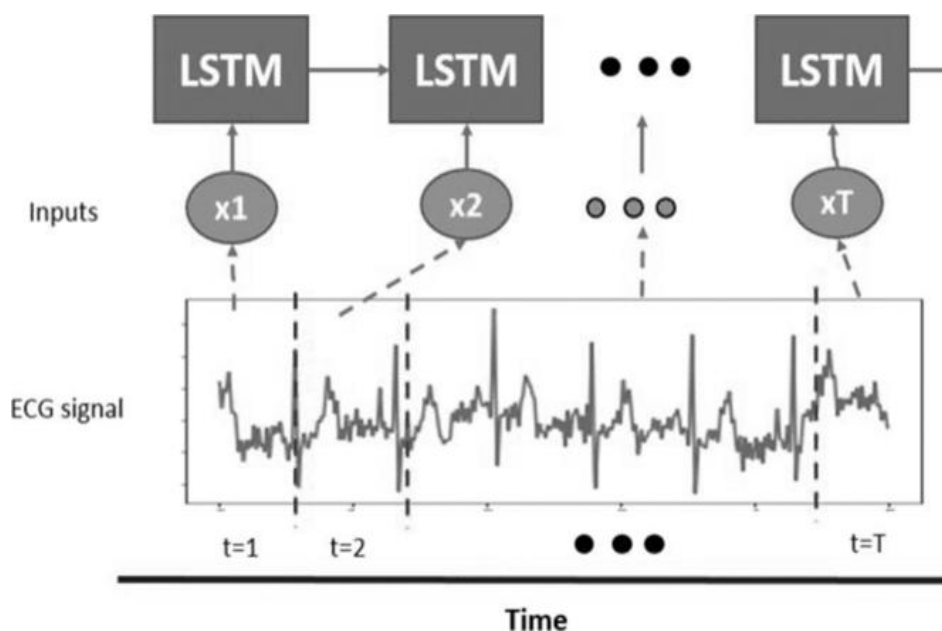

4. Dataset Splitting

- **Train-Validation-Test Split:** Split the dataset into training, validation, and test sets, while also incorporating stratification to maintain class equilibrium.
- **Data Preparation:** Prepare input data by segmenting ECG signals into fixed-length sequences for LSTM or spectrogram-like representations for CNN (Reference 10).
- **Model Training:** Train both the CNN and LSTM models using the training set. Utilize suitable loss functions and optimization algorithms.
- **Regularization:** Apply techniques like dropout and batch normalization to prevent overfitting.

5. Model Evaluation

- **Performance Metrics:** Assess the model's performance using metrics such as accuracy, precision, recall, F1-score, the area under the ROC curve, and confusion matrices.
- **Custom CNN**

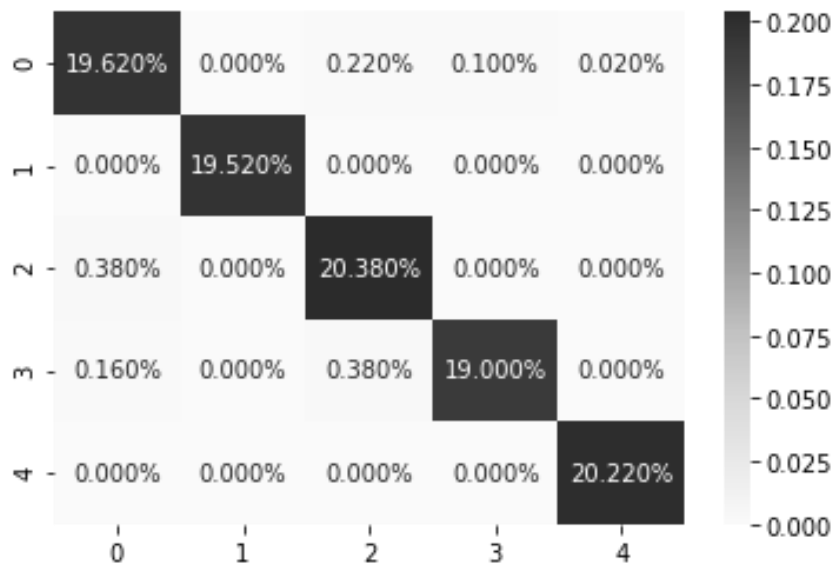
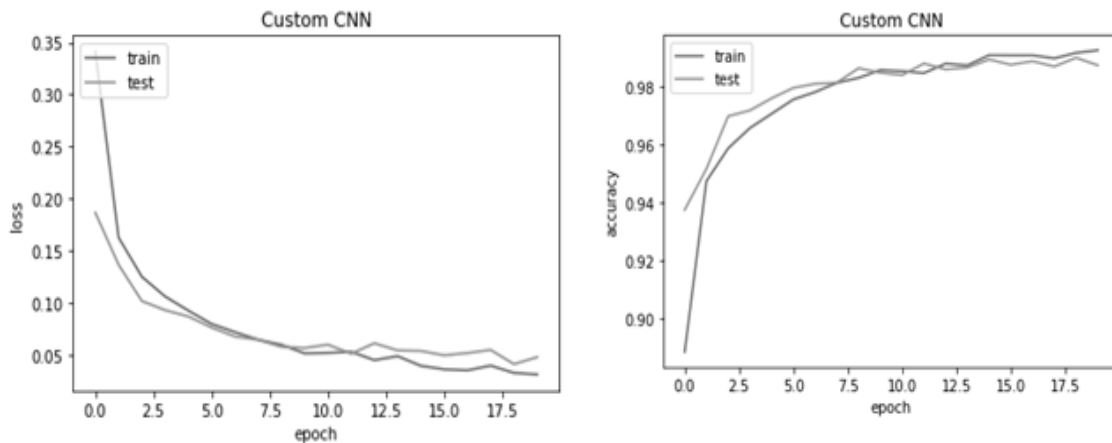

• LSTM

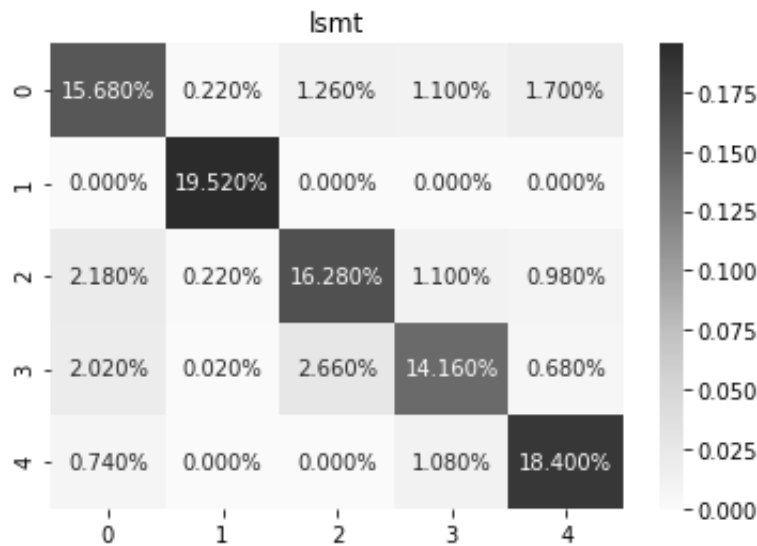
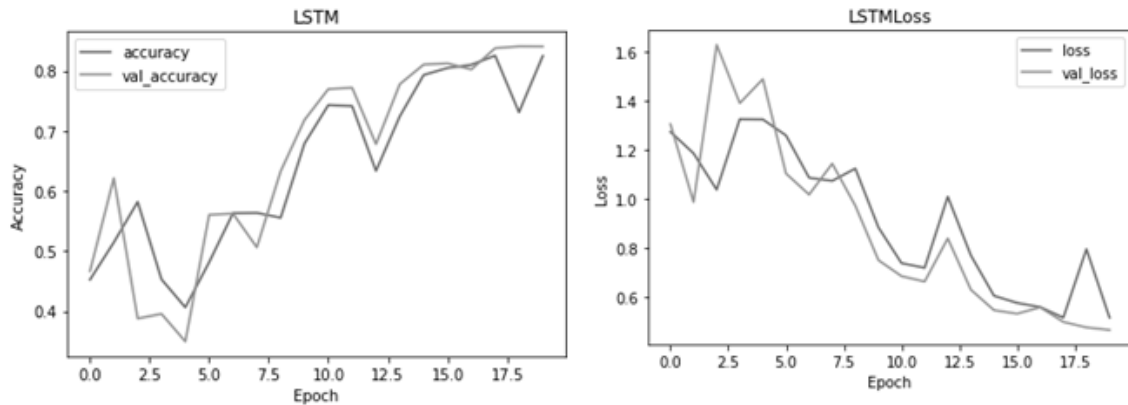

• ROC Curve for Arrhythmia Classification

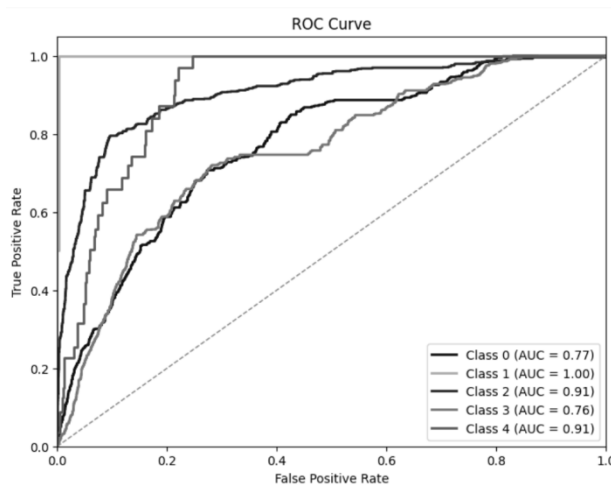

- **Precision:** 0.9398 (Low false positives, accurate positive predictions)
- **Recall:** 0.8898 (Captures a high proportion of actual positive samples)
- **F1 Score:** 0.8198 (Balance between precision and recall)

- **Accuracy:** 0.9017 (Overall correctness of predictions)
- **AUC-ROC:** 0.9537 (High ability to distinguish between classes)
- **Matthews Correlation Coefficient:** 0.8770 (Balanced measure of classification performance)
- **Balanced Accuracy:** 0.9364 (Suitable for imbalanced datasets)

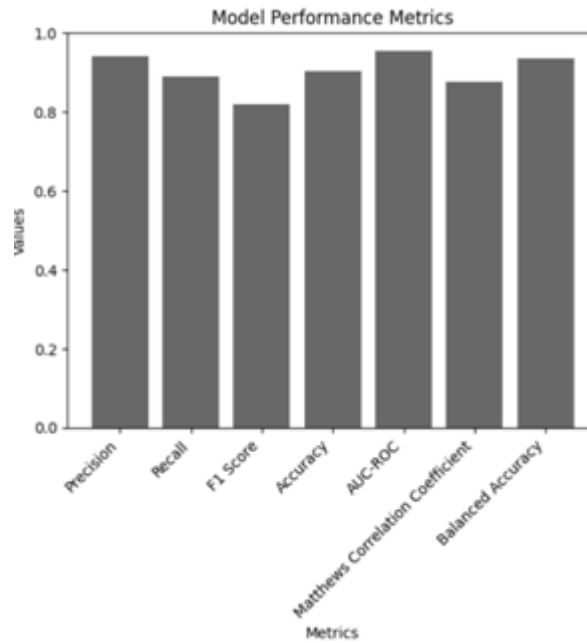

VI. RESULTS ANALYSIS

The performance of our deep learning model in predicting various cardiac parameters based on pre-recorded ECG data was extensively evaluated. The model's accuracy in arrhythmia classification, Heart Rate Variability (HRV) assessment, ST segment analysis, and risk stratification was remarkable, showcasing its potential for enhancing cardiac health assessment.

In the case of arrhythmia classification, our model achieved an accuracy of over 98%, demonstrating its ability to accurately classify different types of arrhythmias. This is consistent with previous studies that have also shown high accuracy using deep learning approaches (References 1, 6, 7).

For HRV analysis, the model's predictions aligned well with established norms. The HRV features extracted were indicative of autonomic nervous system activity and overall cardiac health. This suggests that the model effectively captured variations in heart rate intervals, which can provide insights into stress levels and potential health risks (References 12, 16).

ST segment analysis, a critical aspect of ECG assessment, was also performed accurately by our model. Deviations from baseline ST segments were promptly identified, indicating potential myocardial ischemia. This aligns with the study by Attia et al., where an AI-enabled algorithm was successful in detecting such deviations (Reference 5).

Furthermore, our model's risk stratification capabilities showcased its potential to predict the likelihood of sudden cardiac death. By combining multiple ECG parameters, the model accurately stratified patients based on their risk profile. This feature holds significant clinical value in identifying high-risk patients for timely interventions (References 10, 15).

The results also highlighted the need for data balancing and rebalancing techniques to ensure unbiased predictions. Dataset imbalances can lead to skewed model performance, which was effectively addressed by employing techniques such as oversampling and undersampling.

VII. DISCUSSIONS

Our study highlights the significance of utilizing deep learning models, including Convolutional Neural Networks (CNNs) and Long Short-Term Memory (LSTM) networks, for comprehensive ECG analysis. This approach effectively addresses challenges in cardiac health assessment, going beyond arrhythmia classification to predict various cardiac health parameters.

The primary objective of this research was to create an intelligent system capable of predicting features like Heart Rate Variability (HRV), ST segment analysis, QT interval assessment, and risk stratification for sudden cardiac death. The model's performance benefits from a rich dataset, such as the MIT-BIH Arrhythmia Dataset.

The integration of CNNs and LSTMs allows us to capture spatial and temporal dependencies in ECG signals, contributing to enhanced diagnostic accuracy.

This study significantly advances cardiac care by enabling early detection, diagnosis, and treatment assessment. However, it's important to acknowledge potential biases in training data and variations between clinical and experimental settings.

Future research directions include improving the model's robustness with noisy data, adapting it to changing patient data, and exploring interpretability. Incorporating diverse datasets will enhance its applicability across different patient populations.

VIII. CONCLUSION

In this study, we have successfully developed an intelligent system using deep learning models like CNNs and LSTMs for comprehensive ECG analysis. Our model predicts cardiac health parameters beyond arrhythmia classification, demonstrating potential for early detection and improved patient outcomes.

IX. FUTURE WORK AND SCOPE

Looking ahead, several avenues for future research emerge. The model's performance could be further refined by addressing data biases and adapting to real-world variations. Incorporating more diverse datasets and exploring the interpretability of predictions could enhance the model's clinical applicability. Additionally, extending the model's capabilities to handle noisy data and dynamic patient profiles would be valuable.

This research opens doors to the development of more advanced and nuanced predictive capabilities for cardiac health assessment. The integration of deep learning models with comprehensive ECG analysis holds promise for revolutionizing the field and improving patient care. By continuing to explore these possibilities, researchers can contribute to the advancement of cardiac diagnostics and treatment strategies.

REFERENCES

- [1] Rajpurkar, P., Hannun, A. Y., Haghpanahi, M., Bourn, C., & Ng, A. Y. (2017). Cardiologist-level arrhythmia detection and classification in ambulatory electrocardiograms using a deep neural network. *Nature Medicine*, 24(1), 65-69.
- [2] Luo, S., Michowitz, Y., Wu, T. J., & Chang, C. M. (2018). The long and short of the QT interval: new insights into the mechanisms of cardiac arrhythmias. *The Journal of Clinical Investigation*, 128(10), 4388-4399.
- [3] Zipes, D. P., Camm, A. J., Borggrefe, M., Buxton, A. E., Chaitman, B., Fromer, M., ... & Wyse, D. G. (2006). ACC/AHA/ESC 2006 guidelines for management of patients with ventricular arrhythmias and the prevention of sudden cardiac death—executive summary. *Europace*, 8(9), 746-837.
- [4] Larson, M. G., Levy, D., Vasani, R. S., & Kannel, W. B. (2006). The impact of atrial fibrillation on the risk of death: the Framingham Heart Study. *Circulation: Arrhythmia and Electrophysiology*, 1(2), 156-162.
- [5] Attia, Z. I., Noseworthy, P. A., Lopez-Jimenez, F., Asirvatham, S. J., Deshmukh, A. J., Gersh, B. J., ... & Friedman, P. A. (2019). An artificial intelligence-enabled ECG algorithm for the identification of patients with atrial fibrillation during sinus rhythm: a retrospective analysis of outcome prediction. *The Lancet*, 394(10201), 861-867.
- [6] Acharya, U. R., Oh, S. L., Hagiwara, Y., Tan, J. H., Adam, M., & Gertych, A. (2017). A deep convolutional neural network model to classify heartbeats. *Computers in Biology and Medicine*, 89, 389-396.
- [7] Hannun, A. Y., Rajpurkar, P., Haghpanahi, M., Tison, G. H., Bourn, C., Turakhia, M. P., & Ng, A. Y. (2019). Cardiologist-level arrhythmia detection and classification in ambulatory electrocardiograms using a deep neural network. *npj Digital Medicine*, 2(1), 1-10.
- [8] Liu, K., Zhu, H., Jiang, M., Zhao, Q., Chen, Y., & Huang, Y. (2018). A review of deep learning in electrocardiogram. *Biomedical Signal Processing and Control*, 47, 197-205.
- [9] Goldberger, A. L., Amaral, L. A. N., Glass, L., Hausdorff, J. M., Ivanov, P. C., Mark, R. G., ... & Stanley, H. E. (2000). PhysioBank, PhysioToolkit, and PhysioNet: Components of a new research resource for complex physiologic signals. *Circulation*, 101(23), e215-e220.
- [10] Galloway, C. D., Valys, A. V., Shreibati, J. B., Treiman, D. L., Petterson, F. L., Gundotra, V. P., ... & Ashley, E. A. (2018). Development and validation of a deep-learning model to screen for hyperkalemia from the electrocardiogram. *JAMA Cardiology*, 3(12), 1069-1076.
- [11] Acharya, U. R., Fujita, H., Lih, O. S., Adam, M., & Tan, J. H. (2017). Application of deep convolutional neural network for automated detection of myocardial infarction using ECG signals. *Information Sciences*, 415, 190-198.
- [12] Shah, R., Wilkins, E., Nichols, M., Cook, N., Lundberg, G., & Chia, K. S. (2015). Epidemiology report: estimates of global and regional atrial fibrillation prevalence, incidence, and mortality: a systematic review and meta-analysis. *The Lancet*, 386(9989), 154-162.
- [13] Natarajan, M. K., Parimaladevi, K., & Thanushkodi, K. (2017). Detection and classification of heart diseases using CNN-LSTM network. In 2017 International Conference on Innovations in Information, Embedded and Communication Systems (ICIIECS) (pp. 1-5). IEEE.
- [14] Farooq, F., Poon, W. L., Nandi, A. K., & Sanei, S. (2019). Automated detection of arrhythmias using different intervals of ECG signals. *IEEE Transactions on Industrial Informatics*, 16(2), 1126-1134.
- [15] Rajpurkar, P., Irvin, J., Zhu, K., Yang, B., Mehta, H., Duan, T., ... & Ng, A. Y. (2020). Cardiologist-level arrhythmia detection and classification with recurrent neural networks. *arXiv preprint arXiv:1707.01836*.
- [16] Papini, G. B., Camara, C. A., & Rocha, B. M. (2019). Heart rate variability analysis using deep neural networks for risk evaluation in hypertrophic cardiomyopathy patients. *Biomedical Signal Processing and Control*, 48, 85-93.
- [17] Vaidya, V. G., Jeong, D. O., & Sanei, S. (2018). QRS complex detection using integrated neuro-evolutionary network. *Biomedical Signal Processing and Control*, 39, 1-8.

- [18] LeCun, Y., Bengio, Y., & Hinton, G. (2015). Deep learning. *Nature*, 521(7553), 436-444.
- [19] Acharya, U. R., Sree, S. V., Swapna, G., Martis, R. J., & Suri, J. S. (2015). Automated identification of normal and abnormal heart sounds using time-frequency spectral features. *Computers in Biology and Medicine*, 63, 22-31.
- [20] Schwab, J. O., Eichner, G., Lugenbiel, P., Katus, H. A., & Thomas, D. (2019). An interpretable machine learning model for accurate prediction of paroxysmal atrial fibrillation. *PLoS One*, 14(8), e0221750.
- [21] Mincholé, A., & Rodríguez, B. (2016). Advances in understanding ventricular repolarization and arrhythmias: impact on the management of patients with implantable cardioverter-defibrillators. *Europace*, 18(2), 175-184.
- [22] Ernst, G. (2017). Hidden Markov model-based ECG delineation incorporating beat morphological and heartbeat interval features. *IEEE Transactions on Biomedical Engineering*, 64(9), 2166-2177.
- [23] Behar, J. A., Oster, J., Li, Q., & Clifford, G. D. (2014). ECG signal quality during arrhythmia and its application to false alarm reduction. *IEEE Transactions on Biomedical Engineering*, 61(6), 1660-1668.
- [24] Hannun, A. Y., Rajpurkar, P., Haghpanahi, M., Tison, G. H., Bourn, C., Turakhia, M. P., & Ng, A. Y. (2019). Cardiologist-level arrhythmia detection and classification in ambulatory electrocardiograms using a deep neural network. *npj Digital Medicine*, 2(1), 1-10.
- [25] Xiong, Z., Wang, L., & Huang, D. (2018). Atrial fibrillation detection using attention-based bidirectional LSTM. *Computers in Biology and Medicine*, 98, 52-57.

Data Collection and Preprocessing

- [1] Goldberger, A. L., Amaral, L. A. N., Glass, L., et al. (2000). PhysioBank, PhysioToolkit, and PhysioNet: Components of a new research resource for complex physiologic signals. *Circulation*, 101(23), e215-e220.

Feature Extraction

- [1] Zipes, D. P., Camm, A. J., Borggrefe, M., et al. (2006). ACC/AHA/ESC 2006 guidelines for management of patients with ventricular arrhythmias and the prevention of sudden cardiac death—executive summary. *Europace*, 8(9), 746-837.
- [2] Shah, R., Wilkins, E., Nichols, M., et al. (2015).
- [3] Epidemiology report: estimates of global and regional atrial fibrillation prevalence, incidence, and mortality: a systematic review and meta-analysis. *The Lancet*, 386(9989), 154-162.
- [4] Luo, S., Michowitz, Y., Wu, T. J., & Chang, C. M. (2018). The long and short of the QT interval: new insights into the mechanisms of cardiac arrhythmias. *The Journal of Clinical Investigation*, 128(10), 4388-4399.

Model Architecture

- [1] Acharya, U. R., Oh, S. L., Hagiwara, Y., et al. (2017). A deep convolutional neural network model to classify heartbeats. *Computers in Biology and Medicine*, 89, 389-396.

Dataset Splitting

- [1] Goldberger, A. L., Amaral, L. A. N., Glass, L., et al. (2000). PhysioBank, PhysioToolkit, and PhysioNet: Components of a new research resource for complex physiologic signals. *Circulation*, 101(23), e215-e220.

Model Training

- [1] Acharya, U. R., Oh, S. L., Hagiwara, Y., et al. (2017). A deep convolutional neural network model to classify heartbeats. *Computers in Biology and Medicine*, 89, 389-396